

PRODUCT DATA SHEET
 Sheet 1 - February 2008

Truss Metalwork fixings
 (by Cullen Building Products)

TC Truss Clip
 Used for fixing single trusses to wallplate

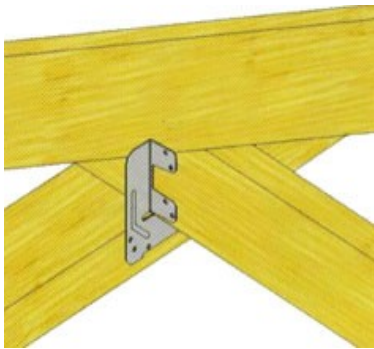

TS Truss Hanger
 Used for fixing single & girder trusses to girder trusses

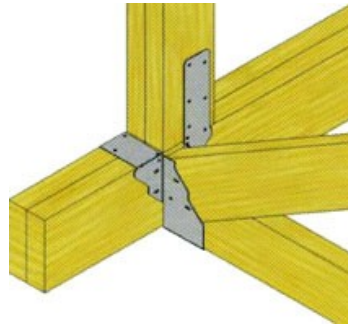

FBL/FBR Framing Anchor
 Used for fixing all girder trusses to wallplate

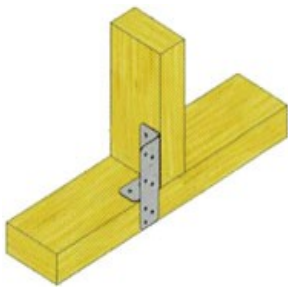

MHE Multi Hanger
 Used for fixing girder trusses to girder trusses

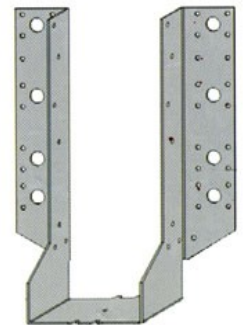
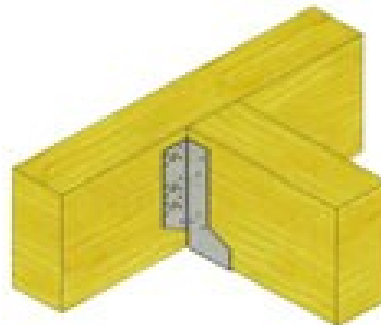

TM Hanger
 Used for fixing loose infill, mono & small std trusses to wallplate

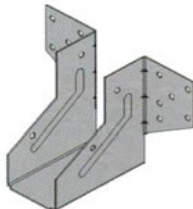
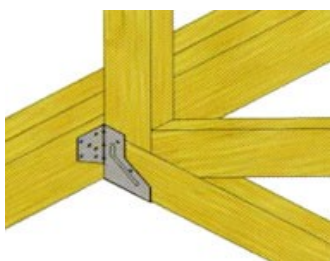

JH Masonry Joist Hangers
 Used for fixing trusses directly to brick or blockwork.

